



# Pavers



"The paving design of a project has a strong influence on the project's character, its coherence, and, ultimately, on its meaning. A pavement can facilitate connections between the parts of a built environment, and to the person using that space."

- Barbara Lien



At VYARA, we believe that it is possible to achieve all business goals ethically, in a mutually rewarding and cordial manner. We are committed to creating products with high technical integrity and expertise that significantly enhance the user's experience of the space.

Our cutting-edge product ranges, particularly the extensive range of Vacuum Wet pressed kerbs for all details, the Melange series, Flags and Cobbles, compete with the best in the industry and are among the finest in the world.

## Index

HSF	High Strength High Finish Pavers	3
EcoPave	Environment Friendly Paving	11
Cobble Square	Timeless Small Aspect Square Paving	13
Cobble Fan	Radial Cobble Paving Stones	15
Combi Cobbles	Modules in Square and Rectangular Shapes	17
Escalon	Stone Finish Modular Paving Planks	19
Decastone	Stone Finish Modular Paving with Ten Different Stones	21
Decastone Neo	Stone Finish Modular Paving with Ten Different Stones	23
Rustico	Stone Finish Modular Paving with Large Spacers	25
Beganit Neo	Stone Finish Modular Paving without Chamfers	27
Mélange	Colour Blended Concrete Paving Stones	29
Paver Finishes	Shotblasted, PremierShield and Rustic Finishes	33
Flagstones	Paving Stones of 300*300 MM or Larger Size	35
Bellezza	Wet Cast Range of Pavers	41
Kerbstones	International Quality Concrete Kerbs	45
Etcetera	Additional Supplementary Products	48
Hollow & Solid Blocks	Concrete Building Blocks	49
Other Range	Additional Vyara Range	50
Design Enhancement	Adding Value to Your Paving	51
Block Plant	About VYARA Infrastructure	53

A choice of over 50 **colour shades** are available from the VYARA colour 'master'. Additional shades would be possible to customise on request.





# HSF

At VYARA, we take pride in our High Strength High Finish (HSF) blocks for paving.

We are a rare company that has separate, sophisticated batching and mixing plants for the manufacture of face mix concrete, ensuring the finest quality and highest strength requirements for fine aesthetics. Our commitment to excellence sets us apart and allows us to offer top-of-the-line products to our customers.



Trihex



Trihex Grooves



Eta  
120/100/80/60 mm



Trihex  
80/60 mm



Trihex Grooves  
80/60 mm



Brick  
100/80/60 mm

Infrastructure applications make the most extreme demands on flooring materials. Compromises often lead to disasters. **OPT FOR THE BEST**

Eta



Brick







# HSF

The **Square** paving stone is a timeless and fashionable choice for paving. Available in a range of sizes and thickness options, it is a favourite among designers. We are proud to have supplied all the paving at the iconic Statue of Unity, C.G. Road Ahmedabad, among several other sites.

Our **Equilatero** shape was originally created as a custom requirement for the Sangeet Samrat Naushad Ali Marg (Carter Road Promenade, Bandra, Mumbai), and it offers a wide range of design possibilities. It is perfect for pedestrian use and can also withstand light vehicular traffic. Whether you are looking for a classic or contemporary design, our Square and Equilatero paving stones have you covered.

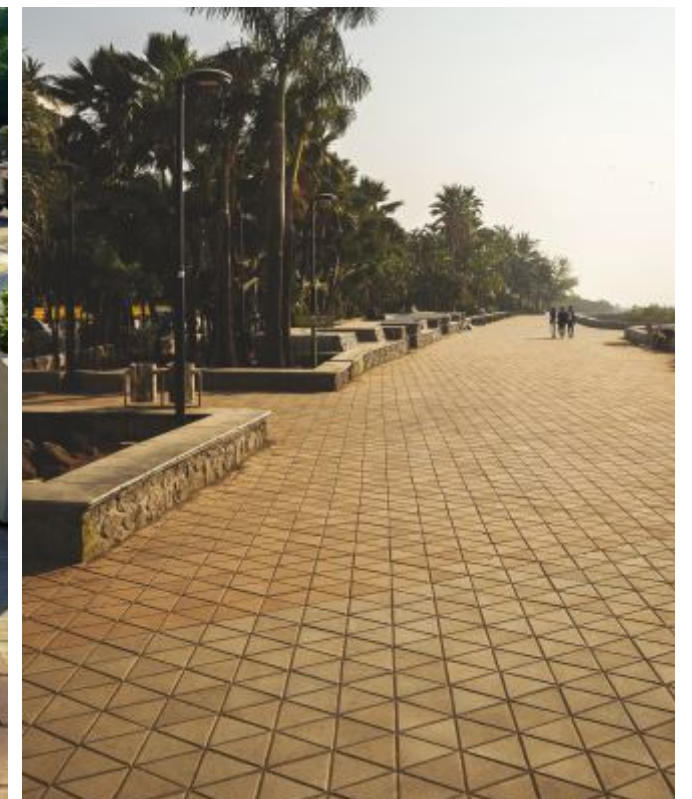
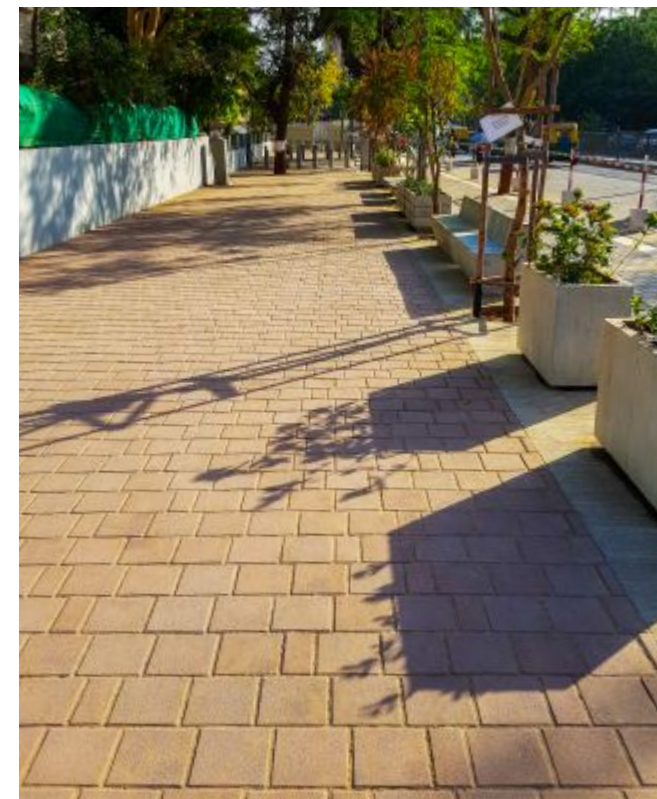

Square  
200\*200\*80/60 mm | 150\*150\*80/60 mm



Equilatero  
60 mm





Quadrastein Stone

# HSF

The **Quadrastein** is a unique paving stone with specially designed "spacer locks" on its sides that provide distinctly superior interlocking capabilities. A smaller plan size offers high strength and potential cost savings compared to 80 mm thick pavers for certain applications. It is available in two finishes: plain and stone. With its high quality, speed, and consistency in supply, the Quadrastein is an ideal choice for high-strength, high-finish applications.



Quadrastein Plain  
80/60 mm



Quadrastein Stone  
80/60 mm





# HSF

The **Strada** comes in a fixed module, but different patterns of applications and colour combinations are possible. Strada can be made available in exciting colours, rustic and shotblasted finishes.

Continuing with the offering of strong as well as aesthetically pleasing paving, Vyara has also the more classic and regular design options for various applications, so that your pavements can look and stay good.

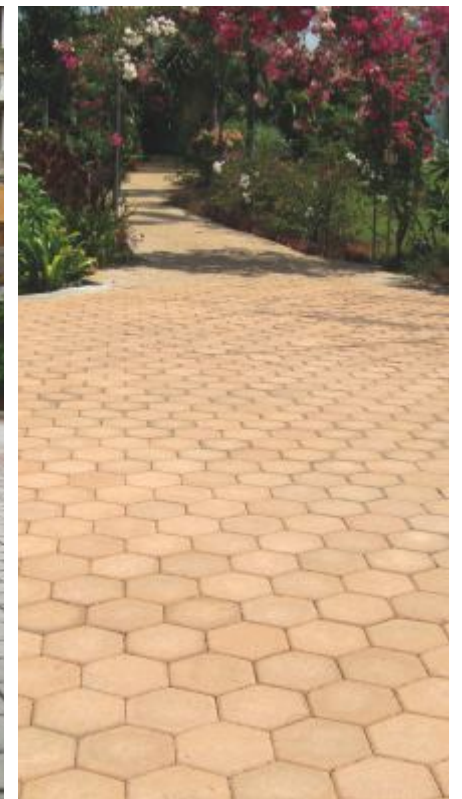

Strada  
80/60 mm



Behaton  
80/60 mm



Hexa  
120/80/60 mm





Verde

# ECOPAWE



The Ecopave range is designed to improve amenities and biodiversity. Properly designed and installed, a site using Ecopave can earn LEED rating points in the following ways:

- Reducing water runoff quantity, which can help recharge aquifers and prevent flooding.
- Cleaning up of water runoff to improve its quality and reduce pollution.
- Using local and recycled materials to reduce the carbon footprint.
- Reducing heat islands.

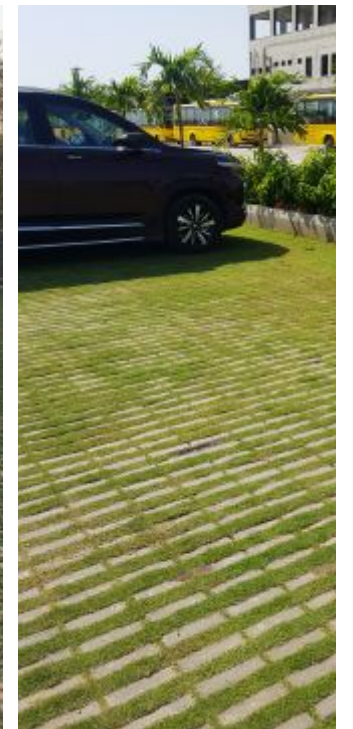

Turf  
250\*250\*80/60 mm



Grid Paver  
600\*400\*75 mm



Verde  
330\*330\*120 mm



Grasline  
200\*200\*80 mm





# COBBLE SQUARE

The concrete Square Cobble stones from VYARA are a practical and aesthetic alternative to natural cobbles. Our square cobbles not only have a clean, modern look with straight lines and controlled color options, but they are also more user-friendly for people with disabilities, the elderly, children, and women wearing high heels.

In addition to their practical benefits, square cobbles can be arranged in a radial pattern beyond a radius of 1 meter, as shown on the opposite page. Whether you are looking for a classic or contemporary design, our square cobble stones offer the perfect solution. Square cobbles are available in Mélange, Shotblasted and Rustic finish options.



Cobble Square  
80/60 mm







# COBBLE FAN

The fan-shaped cobble stone can be used to create interesting fan, circular, and radial patterns in paving. With its strong graphic presence, the cobble fan can add an interesting focal point to your project.

It is important to understand the laying patterns and implications, as well as the requirements for key stones, which will be unique to each project. We recommend getting your drawings checked with us before ordering to ensure that you get the best results.



Cobble Fan  
60 mm



Rustic Cobble Fan  
60 mm







# COMBI COBBLES



Combi Cobbles offer you the possibility to indulge your creative side. Most of VYARA standalone Cobbles, Paving and Flag Stones, owing to their modular sizes, can be seamlessly combined in mix of different sizes and colours to create either subtle or strong graphics.

Finishes available  
Shotblasted | Coated | Rustic

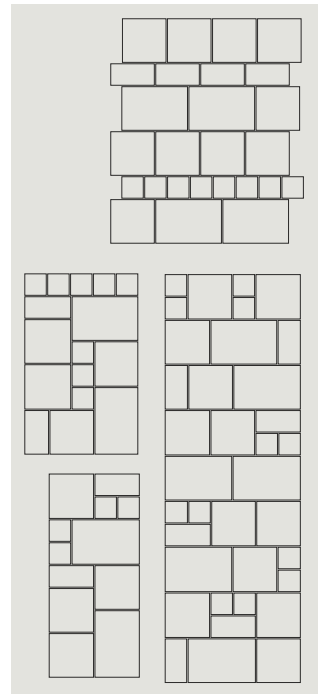

Design options



Cobble Square  
100\*100\*80/60 mm



Brick  
200\*100\*80/60 mm



Square  
200\*200\*80/60 mm



Big Brick  
300\*200\*80/60 mm





Escalon Rains

# ESCALON

The latest entrant in the concrete paving range from VYARA, Escalon is a combination of 16 stones of nine different sizes, the largest of which are 600\*150 and 560\*120 mm, all 100 mm thick.

The carefully chosen thickness, the specially designed combination interlocking spacer bars, the lack of chamfer in the stones, are some of the special features that make the Escalon unique. It is a true pragmatic, quick and inexpensive, yet top end plank format paving.

It is suitable for light vehicular traffic and occasional heavy vehicle.

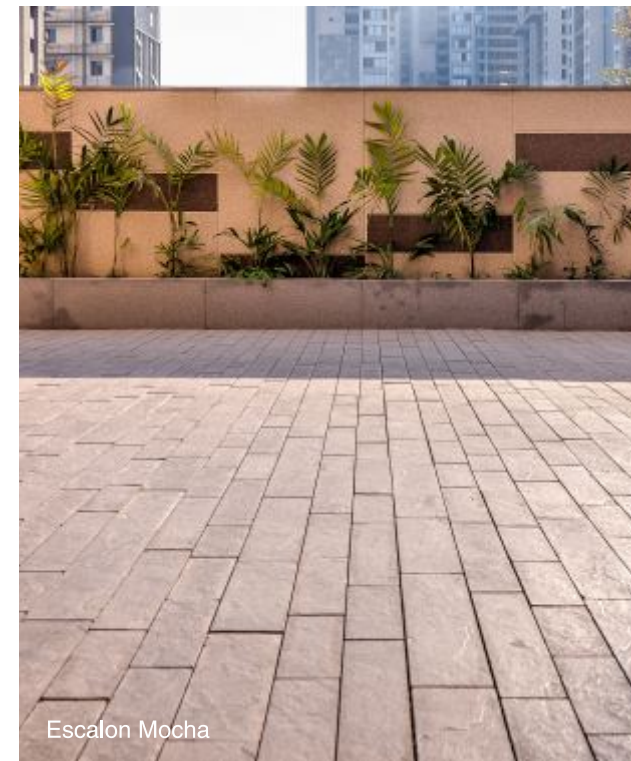

Escalon Mocha

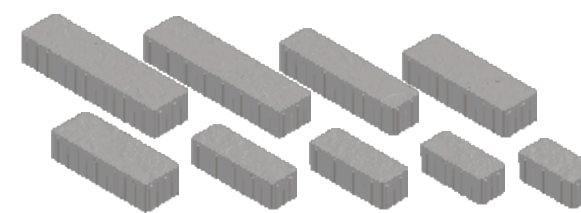

Escalon  
100 mm

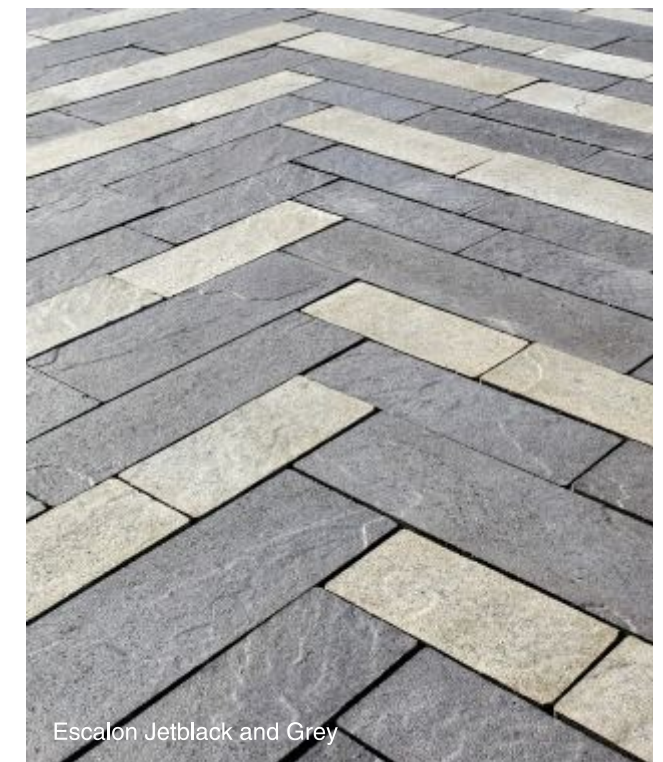

Escalon Jetblack and Grey





# DECASTONE

Decastone is a strong and rugged paving stone in a 80 mm thick module that loves heavy traffic and loading. It is composed of 10 different stone modules, with the largest module measuring no more than 225\*220 mm. It can be laid in a variety of combinations that create horizontal, vertical, or mixed paving lines.

Decastone is ideal for use on internal roads in real estate developments and is available in Plain, Mélange, and Shotblasted finishes.



Decastone Grey and Orange

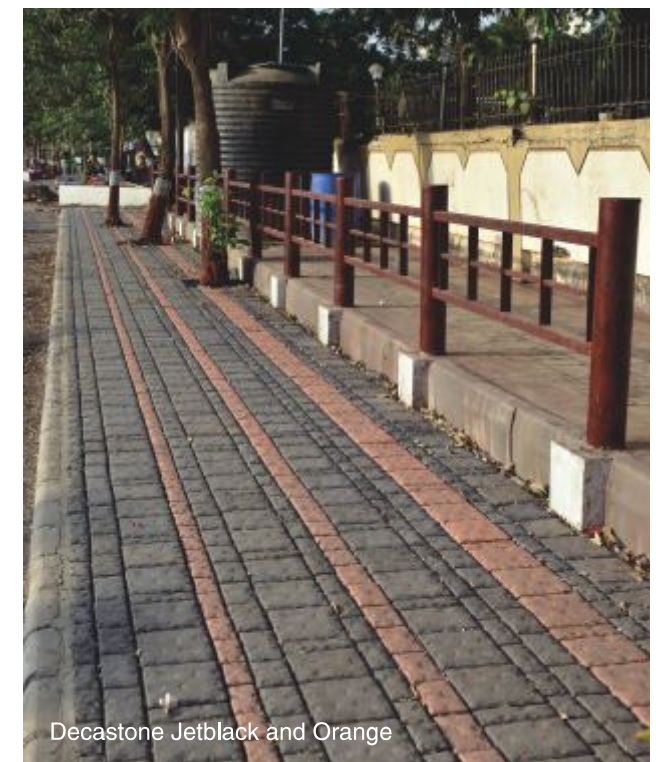

Decastone Jetblack and Orange



Decastone  
80 mm





Decastone Neo Grey and Black

# DECASTONE NEO

Decastone NEO is similar to Decastone but has a nuanced and subtle texture finish that makes it easier to clean and maintain, as well as more friendly for pedestrians. It has gained popularity in recent years due to its excellent in-field performance.

Decastone is ideal for use in a wide range of applications, including traffic roads in real estate developments, and is available in Plain, Mélange and Shotblasted finishes.



Decastone Neo



Decastone Neo Grey

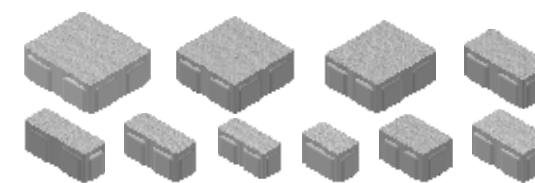

Decastone Neo  
80 mm





Rustico Brown

# RUSTICO

The Rustico is an alluring modular paving solution from VYARA. It is made up of five different stone sizes with a unique slate stone surface. It is designed with wide grooves that do not compromise its interlocking capabilities.

Rustico allows for variations with the use of different colored sands or stone chips as grouts. The Rustico stones are available in the Mélange options.



Rustico Jet Black



Rustico Coffee Bean



Rustico 70 mm





# BEGANIT NEO

The distinctive wedge-shaped modular Beganit has redefined paving stones in India. The Beganit Neo, now offers enhanced features such as a cleaner, more usable surface and greatly reduced edge damage. Its chamfer-free, extremely rock-like yet controlled stone surface provides a more aesthetic and practical alternative to other stones.

Available in 60 mm thickness, they are particularly recommended for internal road paving of residential areas, and other landscaped spaces of all real estate developments, where a tough and yet timeless stone finished paving is required.



Beganit Grey

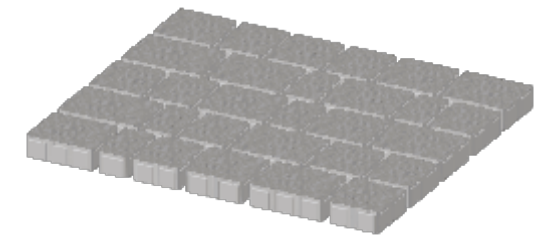

Beganit Rains

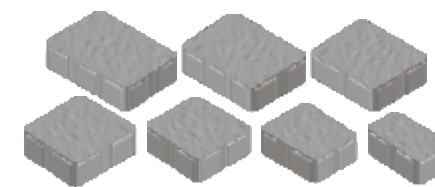

Beganit Neo  
60 mm

Beganit Maple





# MÉLANGE

The Mélange series is the avant-garde range of colour-blended paving from VYARA. It is inspired by some of the finest concrete paving materials available worldwide. With Melange, brought the finest traditions of care and innovation in the manufacture of concrete paving to India.

All Melange products are supplied with **PremierShield Protection** as a standard.

Mélange finish is available in the following designs

Beganit Neo | Brick | Cobble Square | Decastone | Decastone Neo | Escalon | Quadrastein | Rustico

and in the following blend options



Autumn



Coffee Bean



Maple



Nubra



Rains



Terracotta





# MÉLANGE



Mélange is a paving finish option with minimum carbon foot print as the material is supplied with almost no secondary finishing. The colours are blended and integrated in the stones during the manufacturing process itself.

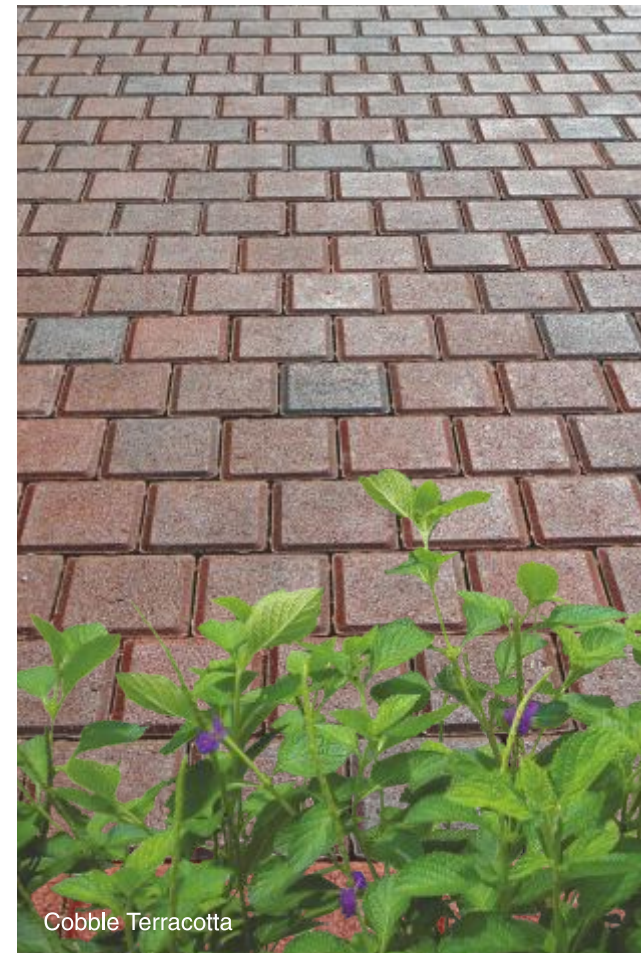

Cobble Terracotta



Rustico Coffee Bean





# PAVER FINISHES



## Shotblasted

Shotblasting is a VYARA forte. VYARA maintains an edge over the competition in quality, supply and range of Shotblasted paving. Shotblasting is ideal for texturing and efflorescence removal from concrete products.

## PremierShield

PremierShield is a premium, integral and topcoat treatment system for paving materials offered by VYARA for the protection of your valuable investment in paving units. PremierShield offers several important enhancing benefits, including water and oil repellence, colour enhancement, shine, prevention of algae and moss formation and is an effective efflorescence preventor.



## Rustic

The tumbling process imparts an antique, worn out look to the small element paving units. The charm of decades and maybe even centuries of distress is reflected in our Rustic range. The antiqued look may be further treated with shotblasting and/or PremierShield coating to further enhance its beauty.





# FLAGSTONES



Concrete block pavings in sizes of 300\*300 mm or more are generally referred to as Concrete Flags or Flagstones.

Concrete flag paving offers a clean, hardwearing and aesthetically pleasing surface, offering designers the potential to use elements of a larger scale than block paving.



300\*300\*80/60 mm



400\*400\*80/60 mm

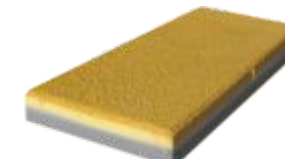

300\*450\*80/60 mm



300\*600\*120/100/80/60 mm



# FLAGSTONES

Our seamlessly modular sizes allow flags to be used in conjunction with smaller paving units. This throws up several design options, some of which are readily available with us.

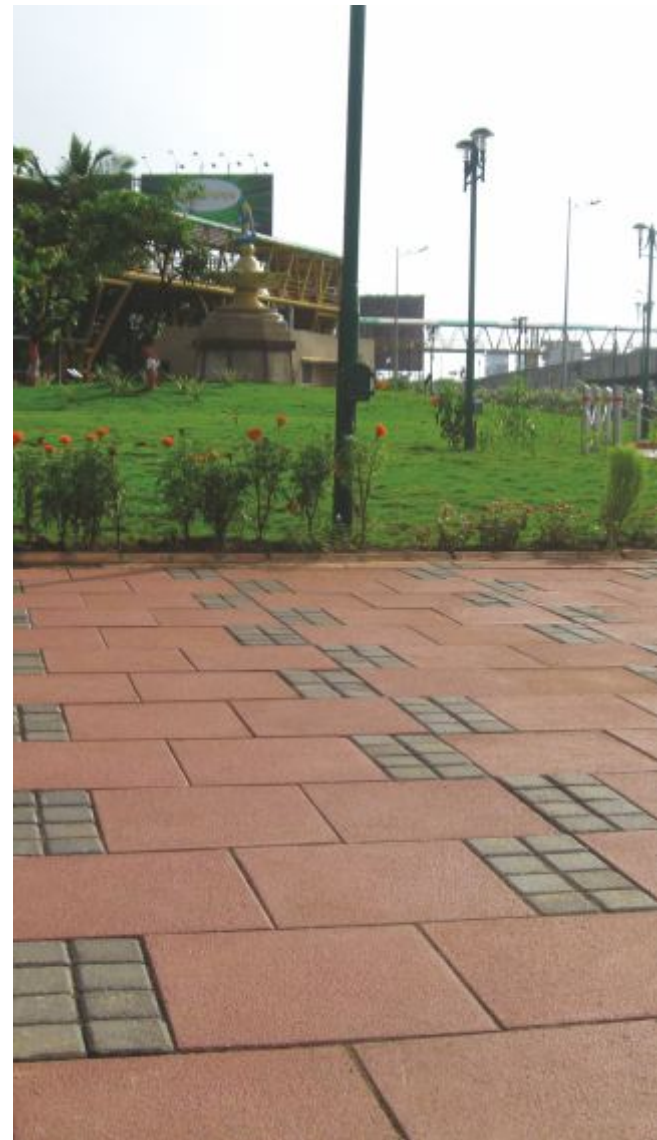

## Applications

Concrete flag paving provides an attractive surface suitable for:

- Pedestrian footways and precincts
- Forecourts and entrances to public buildings
- Approaches and surrounds to residential and industrial buildings
- Areas surrounding shops and offices
- School playgrounds
- Public and private gardens
- Swimming pool surrounds
- Footways where vehicular overrun is unavoidable
- Home zones and urban regeneration
- And other areas where a durable external surface is required



## PLAIN FLAGS

In natural concrete finish



## SHOTBLASTED FLAGS

With wear resistant micro exposed surface, available either with or without sealing



## HONED FLAGS

Semi Polished surface, normally supplied with a sealing



## GRANNAMEXX FLAGS

With a high content and character of granite- Ideal for areas experiencing extremely high pedestrian traffic

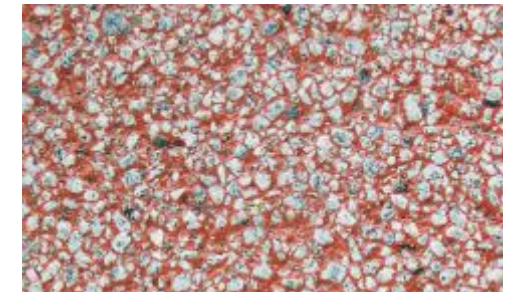

## WASHBETON FLAGS

Beautiful, controlled, exposed aggregate finish with natural river pebbles



## TEXTURED FLAGS

Extremely wide range of textured, patterned, and tactile designs are possible







# BELLEZZA

Wet cast range of lacquer coated pavers.

Trapeze and Rhomba, are beautifully engineered and textured paving stones that afford a myriad of design and colour options.

Functional sizes of the Trapeze and the Rhomba set a standard that almost defines a new level for designing in wet cast paving.



Rhomba



Trapeze



Trapeze





Eta

# BELLEZZA

Our strengths in the wet cast paving segment include:

- Exceptional finish, lustre and strength in products.
- Large capacity to cater to bulk requirements.
- Over 50 colour options available.



Speedbreaker  
380\*380\*110 mm  
Speedbreaker End  
380\*190\*110 mm



Eta  
80/60 mm



Square  
200\*200\*60 mm



Rumbler  
200\*200\*75 mm



Eta



Square



# KERBSTONES

Pre-cast Concrete Kerbs are often referred to as the unsung heroes of roads and streets.

Kerbs serve several functions, not limited to the following:

- They improve the aesthetics and contribute to the paved environment
- They provide additional strength to the edge of the carriageway,
- They deter traffic from mounting on the footway, thereby ensuring the safety of the pedestrians
- Prevent vegetation from encroaching on to the roads

Kerbstones can be effectively used in all urban and infrastructural road and footways, for medians, driveways, school playgrounds, pedestrian precincts, and industrial pavements.

The wide range of products and accessories being produced at VYARA enables designers to provide excellent design details to their clients.



# VACUUM WET PRESS KERBS

VYARA is the first in the country to introduce an extremely wide range of kerbs. These are manufactured using a vacuum wet press process with extremely high hydraulic pressure and simultaneous vacuuming which make them ideal for use as road kerbs. They have an extremely good finish and technically conform to the requirements of EN 1340: 2003 and IS 5758: 2020.

Characteristics of Wetpress Kerbs	Benefits
Very high strength	Long life and value retention of the project. Vehicles can climb over
Large sizes	Fewer joints and better looks
Extremely good finish	Better aesthetics
High abrasion resistance	Lower need for repair and replacement
Low water absorption	Much reduced erosion and maintenance of kerbs
Extremely wide range of products	Allows for most of the details to be catered to

There are four basic profiles to the most common road kerbs used:

- **Half Batter (HB)**- Most frequently used shape, for deflection of traffic and safety of pedestrians
- **Splay (SP)**- To allow traffic to climb over the footway
- **Bull Nose (BN)**- To provide access to vehicles from road to an access point across the road
- **Square (SQ)**- Used as flush kerbs- To provide restraints at FFL

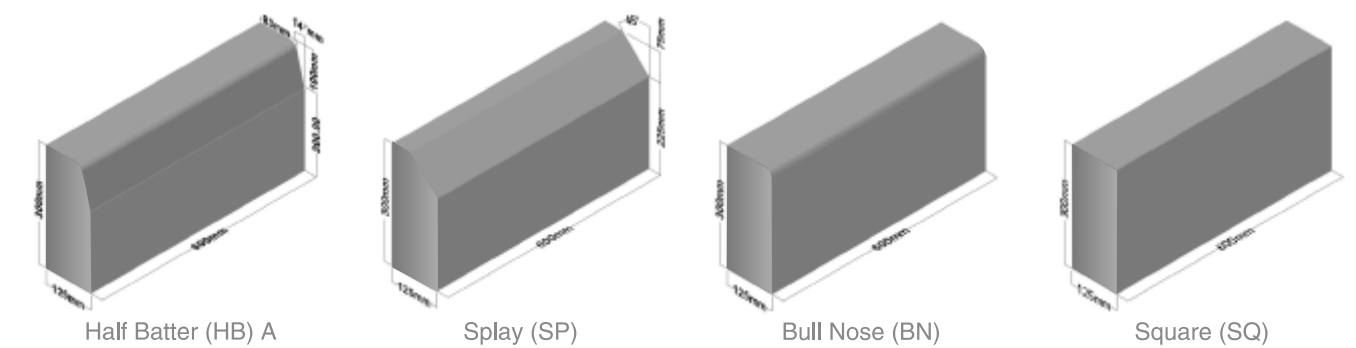

Profile	Length (mm)	Height (mm)	Thickness (mm)
Half Batter (HB) A	600	450/375/300/215/175	150/125/100
Half Batter (HB) A	300	600	150/125/100
Half Batter (HB) B	500	325	165/150
Splay (SP)	600	450/375/300	150/125
Bull Nose (BN)	600	450/375/300/215/175	150/125/100
Bull Nose (BN)	600	300	65
Square (SQ)	600	450/375/300	150/125/100

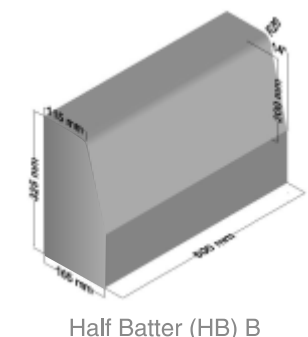

\*Please refer to Kerbstones brochure for the full range



# ACCESSORY KERBS



Accessory Kerbs handle transitions from one type of kerb to another, drops in footways, and provide for radiuses and turnings in roads. These are all necessary to obtain detailed design solutions.

- Transition Kerbs
- Dropper Kerbs
- Radius Kerbs
- Quadrant Kerbs
- Angle Kerbs
- Offlet Kerbs
- Dished Channel
- Sloped Channel
- Gully Kerbs
- L Profiled Kerbs (HB and BN)

These when used together, offer a fairly complete solution to the kerbing needs, whether in the neighborhood, streets or in highways.

\*Please refer to the Kerbstones brochure for the full range.

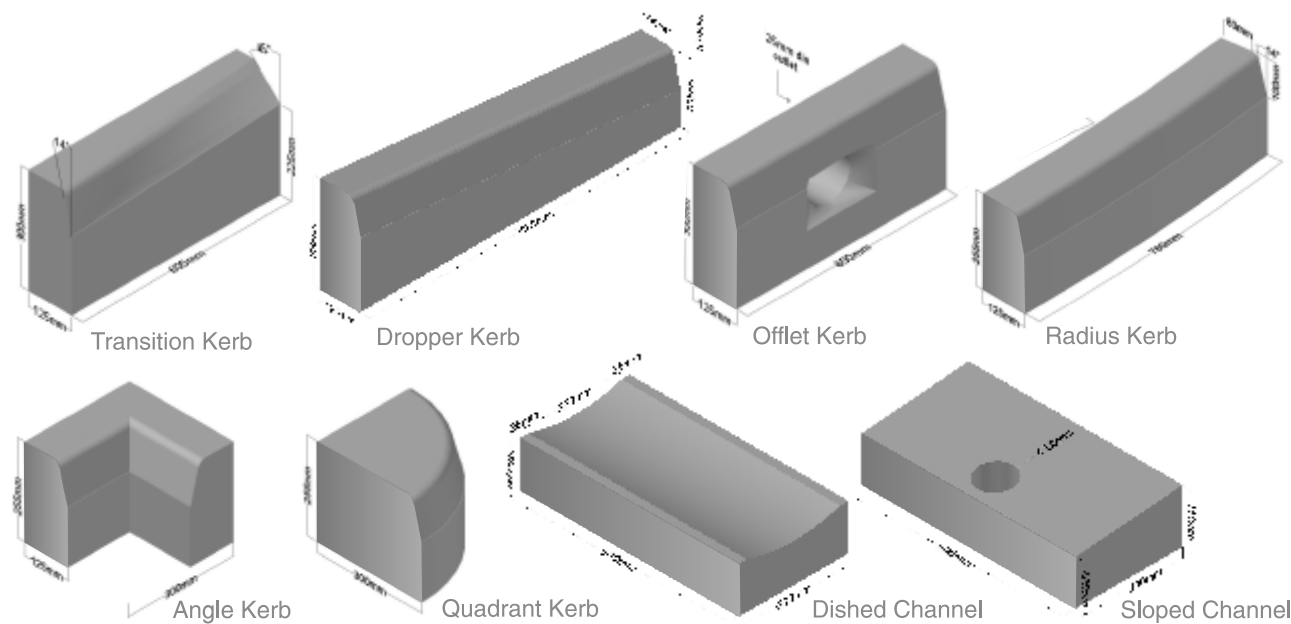

# ETCETERA



Etcetera by VYARA is an expanding range, for situations, which are best served by precast products. Offered in plain or reinforced options, with matching colours and textures.

## DRAIN COVER



Drain Cover  
900\*600\*100 mm  
600\*450\*100/80 mm



Drain Cover  
700\*300\*100/60 mm



Drain Cover  
940\*300\*100 mm

## TREE GUARD



Tree Guard TG-2  
800\*800\*75 mm, ID 500 mm



Tree Guard TG-3  
950\*950\*75 mm, ID 650 mm

## TRENCHSTONE

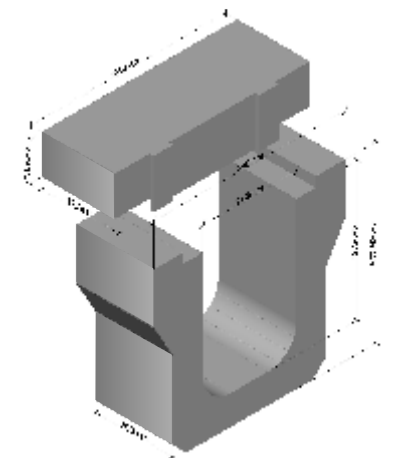

TrenchStone  
490\*450\*200 mm  
Trenchcover  
490\*200\*125 mm



# HOLLOW & SOLID BLOCKS

High Quality Concrete Hollow and Solid blocks as per requirements of IS 2185 can be supplied in bulk.

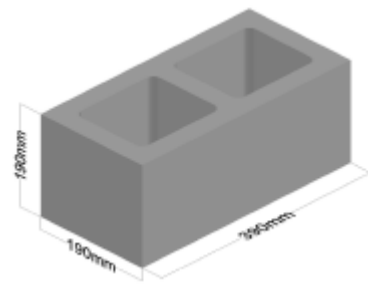

Hollow 200  
390\*190\*190mm

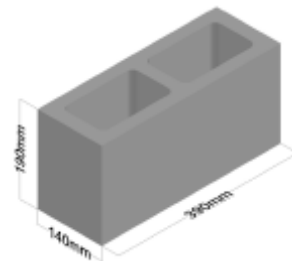

Hollow 150  
390\*190\*140mm

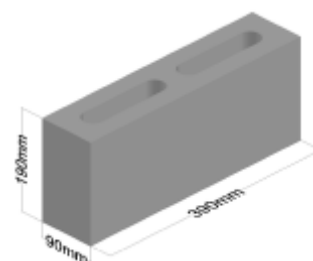

Hollow 100  
390\*190\*90mm

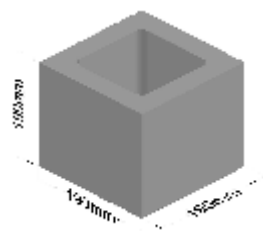

Hollow 200 Half  
190\*190\*190mm

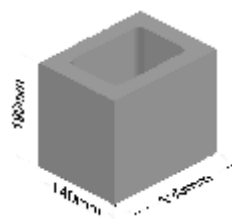

Hollow 150 Half  
190\*190\*140mm

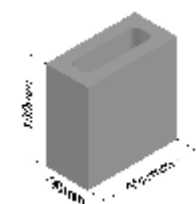

Hollow 100 Half  
190\*190\*90mm

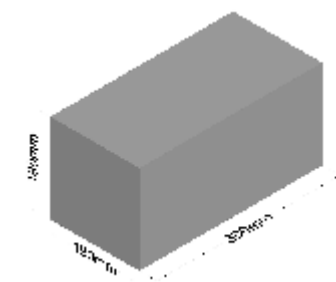

Solid 200  
390\*190\*190mm

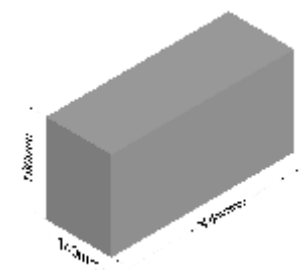

Solid 150  
390\*190\*140mm

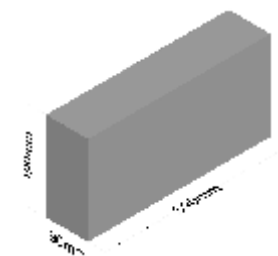

Solid 100  
390\*190\*90mm

# OTHER RANGE

VYARA also offers you a much wider range of products for varied applications, each nuanced and evolved. Do ask for our separate brochures from these ranges too.

## PASSAGIO

Range of concrete tiles for most landscaping applications, including the top notch Pebblino Tiles and the once ubiquitous chequered tiles.



Chequered Tiles

Granamexx Tiles

Shotblasted Tiles

Pebblino Tiles

## TERRAZZO TILES

A bespoke range of concrete terrazzo tiles, crafted with exceptional care and craft, using innovative blend of colours, aggregates, patterns, and textures.

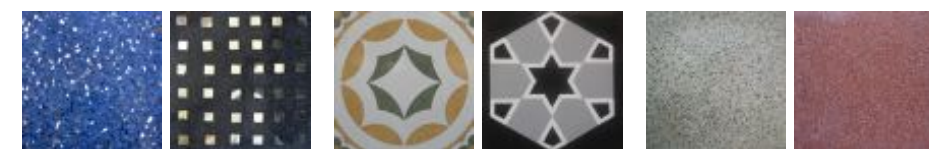

Terrazzo Tiles

Galicha Tiles (Motivo)

Industrial & Terrace Tiles

## FREEFORM

Explore an exquisite range of fine Architectural Premixes from FREEFORM by VYARA for cast on site finishing surfaces of Floors and Walls.



Floors

Wall Finishes

Base Materials

Seal & Protect

DIY



# DESIGN ENHANCEMENT

Other than providing a quality product that is truly required for a particular application, VYARA has undertaken several pioneering initiatives which enhance the functional and aesthetic performance of the hardscaped areas.

## Design and construction of base

At VYARA, we assist you with designing the base for your paving needs.

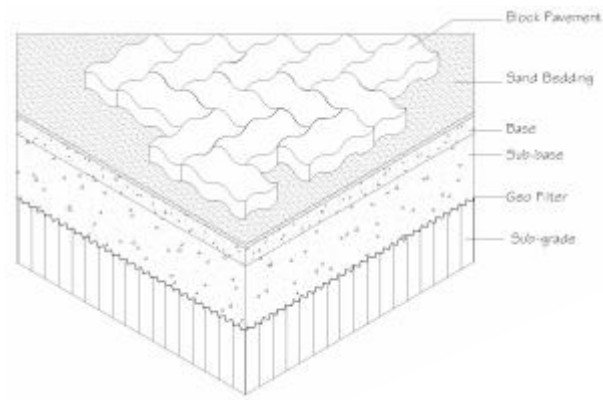

## Overall selection of materials, paving designs and layouts

VYARA can help you in accentuating, human scaling or integrating the pavement with the design legacy of the project and in the process making the user feel accommodated.

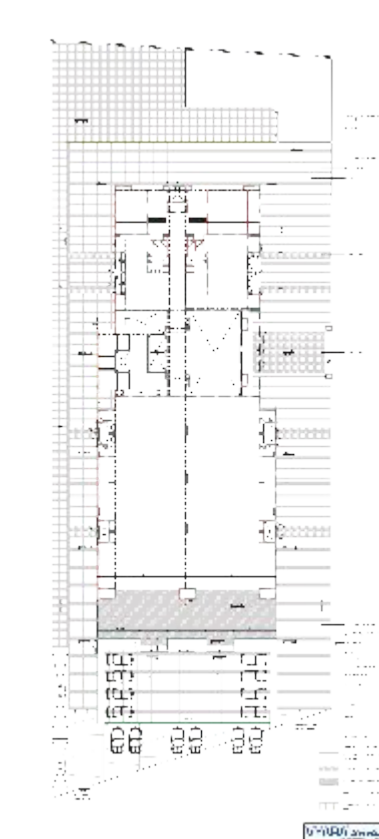

## Edge and border detailing

Simple borders, proper detailing of typical features appearing on site like manholes, road turning etc. and making the correct type of 'cut-ins' greatly enhance the value of the site.

Some simple square and rectangular shapes of stones can be used for effective border details, which largely enhance the pavement.



Cobble Square  
100\*100\*60 mm



Brick  
200\*100\*60 mm



Square  
150\*150\*60 mm  
200\*200\*60 mm

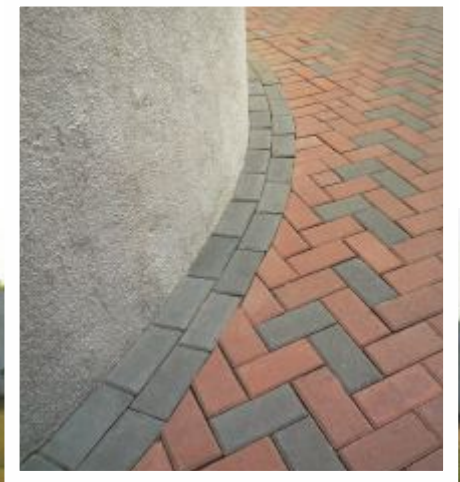



# BLOCK PLANT

Sophisticated Batching and Mixing Plants

Highest strength and consistency in product

Automatic German Block Plants

Possible to execute large volumes in demanding time frames

Fully Automatic Material Handling System

Minimum edge chipping and damage of blocks

Only Special Steel Moulds with High Dimensional Accuracy used

Adds to the beauty and structurally, provides better interlocking to the pavement

Exhaustive Testing for Incoming and Outgoing Products for Conformance

Your product is tested and quality checked, whether you have asked for it or not



Weigh Batching & Mixing



Rekers Block Plant



Elevator



Finger Car



Curing Chambers



Dispatch

## VYARA Profile

- Since 1968
- ISO 9001:2015 certified and BIS Licensee for ISI mark
- Strong Customer, Quality and Value orientation
- Comprehensive Testing of all raw materials, in process and finished goods
- A promise to **improve the experience of the project**



VYARA Testing Lab

## Green Initiatives at VYARA

- Generous use of SCMs
- Very tight process control gives excellent product characteristics while allowing a reduced cement content
- Maximum use of locally available raw materials
- Several initiatives for Material and water reuse and recycling and eco-friendly disposal/ recycling of waste products





# www.vyaratiles.in

**Surat Office (HO):** Vyara Tiles Pvt. Ltd.  
S-1, Shankheshwar Complex,  
Kailash Nagar, Sagrampura,  
Surat- 395002  
Ph: 0261-2472444, 09327447469  
E-mail: [info@vyaratiles.in](mailto:info@vyaratiles.in)

**Ahmedabad Office:** Vyara Tiles  
A-8, Anand Complex, 3rd Floor,  
Nr. Sola Bridge, SG Highway,  
Ahmedabad- 380054  
Ph: 079-27400767, 09374034284  
E-mail: [ahmedabad@vyaratiles.in](mailto:ahmedabad@vyaratiles.in)

**Bharuch Office:** Vyara Tiles  
FF2, RK Avenue Nr. Abhinav Complex  
Zadeshwar Crossing to Shukltirth Road,  
Bharuch, Gujarat 392011  
Ph: 09375568855  
E-mail: [bharuch@vyaratiles.in](mailto:bharuch@vyaratiles.in)

**Mumbai Office:** Vyara Tiles  
61, Discovery Complex,  
Dattapadda Road, Borivali (E),  
Mumbai- 400066  
Ph: 022-28544404, 09322285672  
E-mail: [mumbai@vyaratiles.in](mailto:mumbai@vyaratiles.in)

**Vadodara Office:** Vyara Tiles  
15, Silver Coin Complex,  
Nr. Shrenik Park Char Rasta, Akota  
Vadodara- 390020  
Ph: 09376979755  
E-mail: [vadodara@vyaratiles.in](mailto:vadodara@vyaratiles.in)

Pavers | Flagstones | Cobbles | Kerbstones | Tiles

